

INSTRUCTIONS FOR Mini BOOK FOR DAD

MATERIALS:

- Printable template
- Coloring materials
- Pencils
- Scissors

INSTRUCTIONS:

- Fold in half along the center solid line.
- Unfold then fold in half lengthwise.
- Fold in both sides along the solid lines.
- Unfold the paper, then fold it again in half along the center solid line(look at number 1), so you can still read the words.
- Cut along the dotted line in the center.
- Unfold, then fold it again in half lengthwise (look at number 2).
- Hold each end of the booklet and push both sides inwards to create an "X".
- Close to form pages.

INSTRUCTIONS:

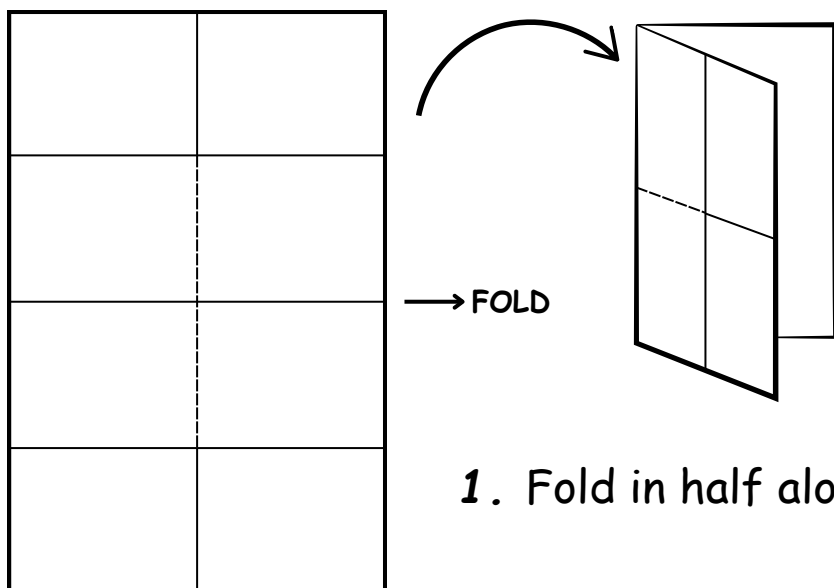

1. Fold in half along the center solid line.

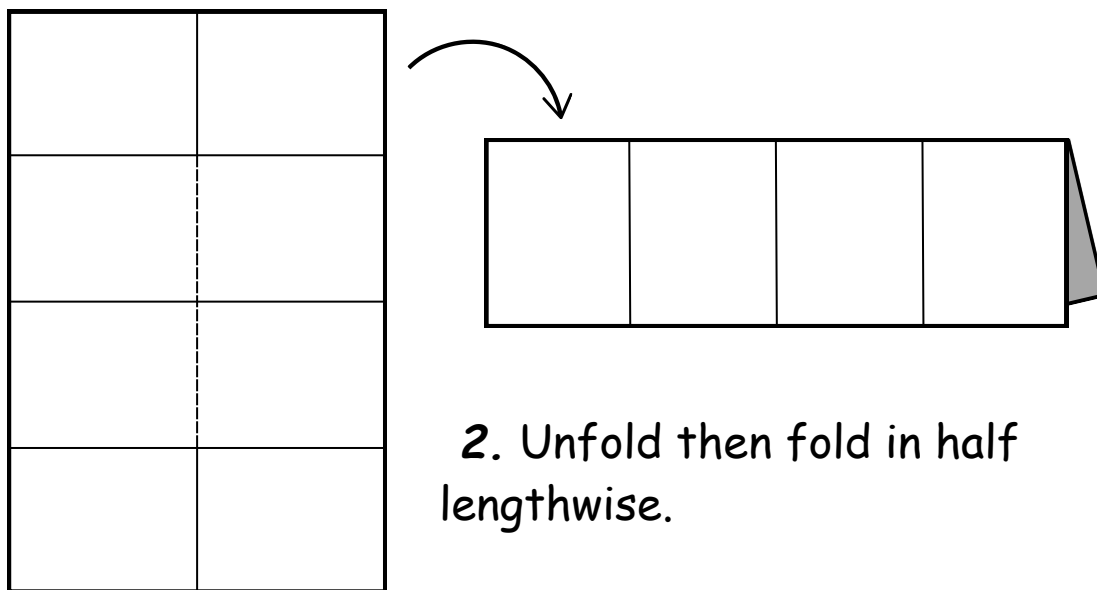

2. Unfold then fold in half lengthwise.

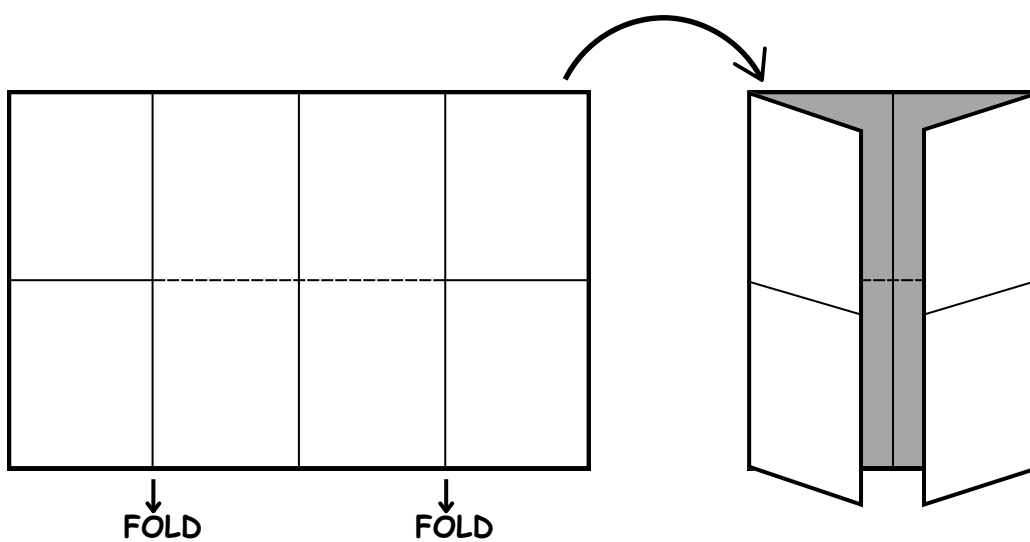

3. Fold in both sides along the solid lines.

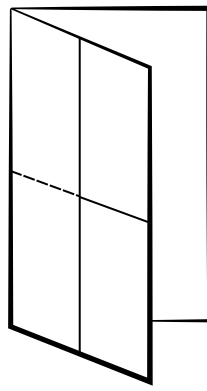
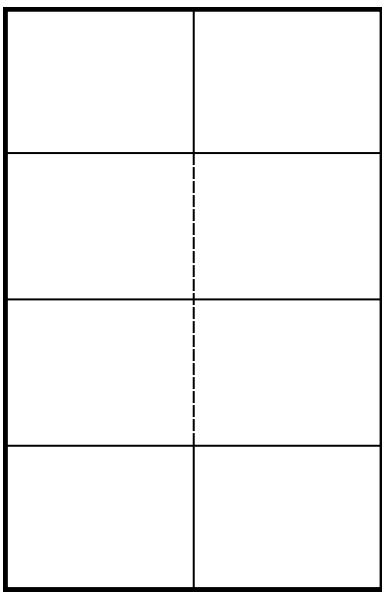

4. Unfold the paper, then fold it again in half along the center solid line (look at number 1), so you can still read the words.

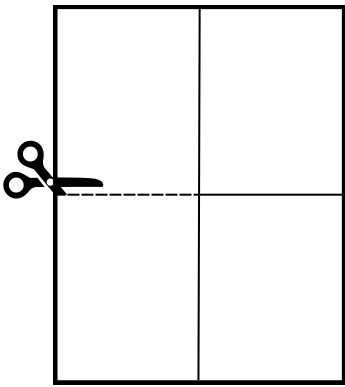

5. Cut along the dotted line in the center.

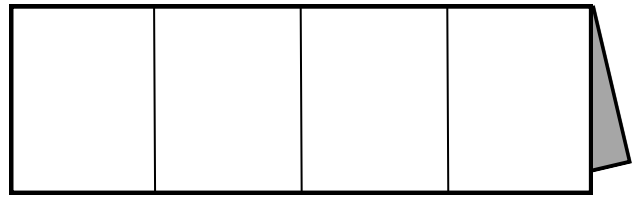

6. Unfold then fold it again in half lengthwise (look at number 2).

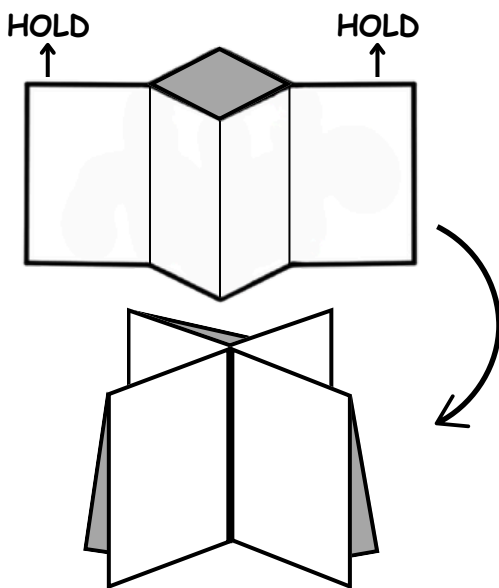

7. Hold each end of the booklet and push both sides inwards to create an "X".

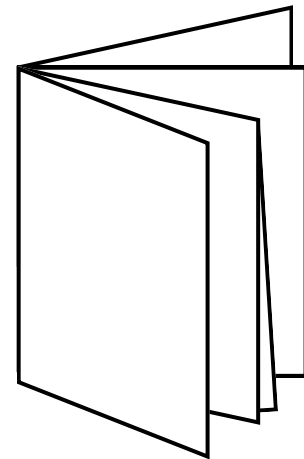

8. Close to form pages.



He is strong, smart, and _____.

He gives the best _____.

He helps me with _____.

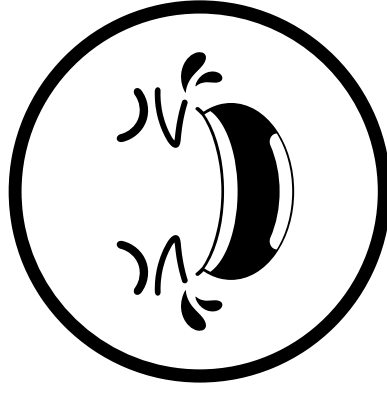

One silly thing my dad
always says is:

"_____"
_____!"
It always makes me laugh!

because he deserves it!

I would give him a _____



I love when we _____

together.

It makes me feel _____.

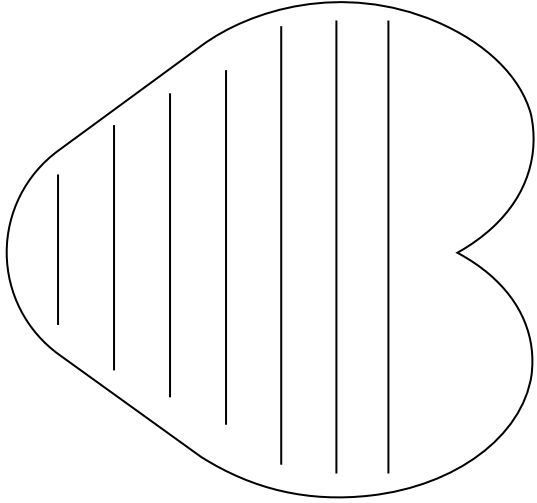
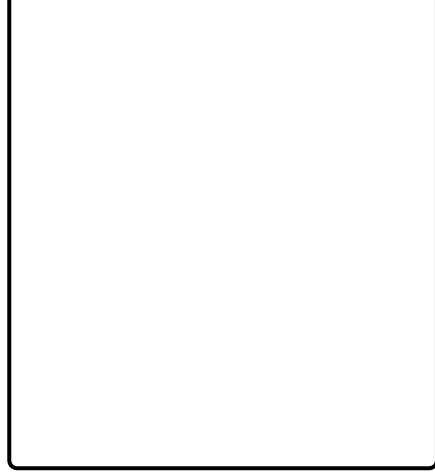

**HAPPY
FATHER'S DAY!**

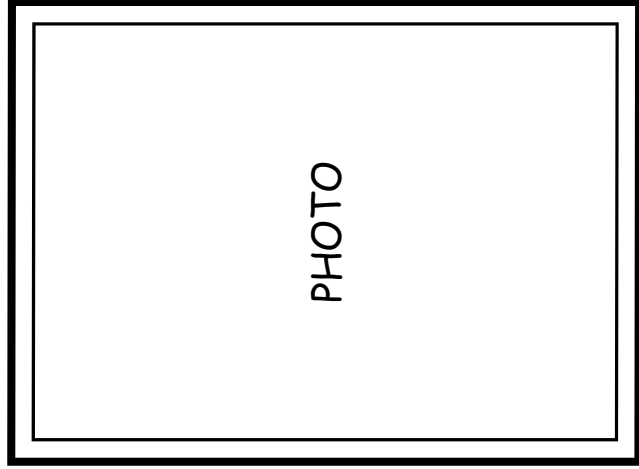

PHOTO

MY DAD LOOKS LIKE...

NAME: _____

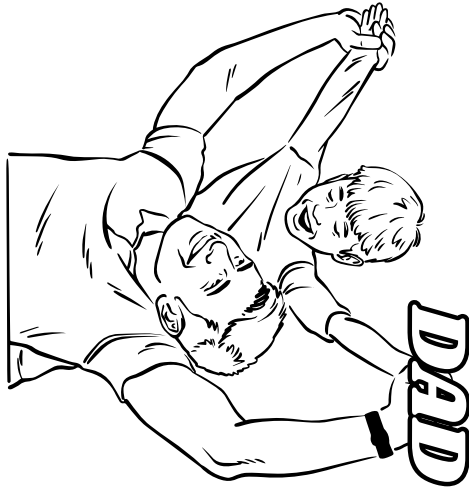

**MY
AMAZING
DAD**

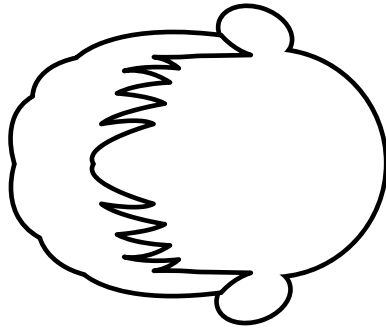

My dad's name is _____

He is _____ years old.

He is really good at _____

He makes the best _____

He makes me feel _____

He helps me _____

He always _____

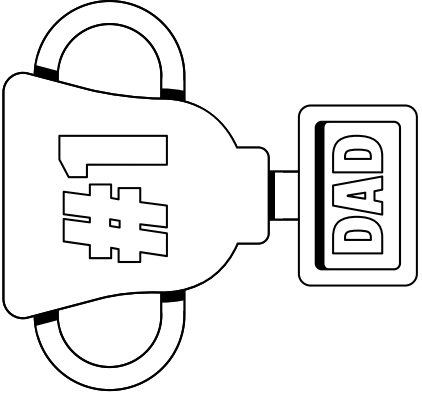

If my dad were a superhero, his powers would be:

- _____
- _____

"This is a picture of me and my dad doing something we love."

THINGS I LOVE ABOUT DAD

- _____
- _____
- _____

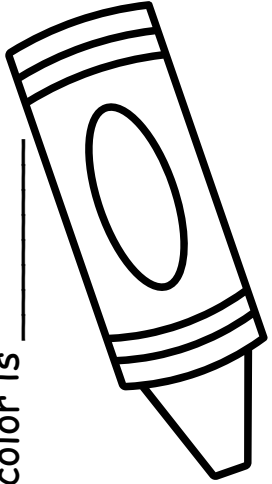

My dad's favorite color is _____

My dad's favorite food is _____

HAPPY Father's DAY

To: _____

From: _____

"THIS IS WHAT MY DAD LOOKS LIKE!"

ALL ABOUT MY DAD



NAME: _____